

Pure50+™ Epoxy Injection Adhesive Anchoring System

ADHESIVES

PRODUCT DESCRIPTION

The Pure50+ is a two-component adhesive anchoring system. The system includes injection adhesive in plastic cartridges, mixing nozzles, dispensing tools and hole cleaning equipment. The Pure50+ is designed for bonding threaded rod and reinforcing bar hardware into drilled holes in solid concrete base materials.

GENERAL APPLICATIONS AND USES

- Bonding threaded rod and reinforcing bar into hardened concrete
- Evaluated for installation and use in dry and wet holes
- Can be installed in a wide range of base material temperatures

FEATURES AND BENEFITS

- + Designed for use with threaded rod and reinforcing bar hardware elements
- + Evaluated and recognized for freeze/thaw performance
- + Cartridge design allows for multiple uses using extra mixing nozzles
- + Mixing nozzles proportion adhesive and provide simple delivery method into drilled holes
- + Evaluated and recognized for long term and short term loading (see performance tables for applicable temperature ranges)

APPROVALS AND LISTINGS

Conforms to requirements of ASTM C 881, Types I, II, IV and V, Grade 3, Classes B & C (also meets Type III except for elongation)

Department of Transportation listings – see www.powers.com or contact transportation agency

Tested in accordance with AC308 for use in structural concrete

Evaluated and qualified by an accredited independent testing laboratory for recognition in concrete

GUIDE SPECIFICATIONS

CSI Divisions: 03151-Concrete Anchoring.

Adhesive anchoring system shall be Pure50+ as supplied by Powers Fasteners, Inc., Brewster, NY. Anchors shall be installed in accordance with published instructions and requirements of the Authority Having Jurisdiction.

SECTION CONTENTS Page No.

General Information 1
 Installation Specifications 2
 Installation Instructions 3
 Performance Data 6
 Ordering Information 7



Pure50+ dual cartridge and mixing nozzle

PACKAGING

Dual (side-by-side) Cartridge

21 fl. oz. (620 mL)

51 fl. oz. (1400 mL)

1:1 mix ratio

STORAGE LIFE & CONDITIONS

Two years in a dry, dark environment with temperature ranging from 41°F and 95°F (5°C to 35°C)

ANCHOR SIZE RANGE (TYP.)

3/8" to 1-1/4" diameter threaded rod
 No. 3 to No. 8 reinforcing bar (rebar)

SUITABLE BASE MATERIALS

Normal-weight concrete

INSTALLATION SPECIFICATIONS

Installation Specifications for Threaded Rod and Reinforcing Bar

Dimension/Property		Notation	Units	Nominal Anchor Size						
Threaded Rod		-	-	3/8"	1/2"	5/8"	3/4"	7/8"	1"	1-1/4"
Reinforcing Bar		-	-	#3	#4	#5	#6	-	#8	-
Nominal anchor diameter		d	in. (mm)	0.375 (9.5)	0.500 (12.7)	0.625 (15.9)	0.750 (19.1)	0.875 (31.8)	0.875 (31.8)	1.250 (31.8)
Nominal diameter of drilled hole		d_o (d_{bit})	in.	7/16 ANSI	9/16 ANSI	3/4 ANSI	7/8 ANSI	1 ANSI	1-1/8 ANSI	1-3/8 ANSI
Minimum embedment		$h_{ef,min}$	in. (mm)	2-3/8 (60)	2-3/4 (70)	3-1/8 (79)	3-1/2 (89)	3-1/2 (89)	4 (102)	5 (127)
Maximum embedment		$h_{ef,max}$	in. (mm)	7-1/2 (191)	10 (254)	12-1/2 (318)	15 (381)	17-1/2 (444)	20 (508)	25 (635)
Minimum concrete member thickness		h_{min}	in. (mm)	$h_{ef} + 1-1/4$ ($h_{ef} + 30$)			$h_{ef} + 2 d_o$			
Minimum spacing distance		s_{min}	in. (mm)	1-7/8 (48)	2-1/2 (64)	3-1/8 (79)	3-3/4 (95)	4-3/8 (24)	5 (127)	6-1/4 (159)
Minimum edge distance ¹		c_{min}	in. (mm)	1-3/4 (44)	1-3/4 (44)	1-3/4 (44)	1-3/4 (44)	1-3/4 (44)	1-3/4 (44)	1-3/4 (44)
Maximum torque (only possible after full cure time of adhesive)	A36 or F1554 Grade 36	T_{max}	ft.- lbs. (N-m)	10 (13)	25 (34)	50 (68)	90 (122)	125 (169)	165 (224)	280 (380)
	F593 Condition CW stainless steel rod or ASTM A193 Grade B7 carbon steel rod	T_{max}	ft.- lbs. (N-m)	15 (21)	33 (45)	60 (81)	105 (142)			
Effective cross sectional area of threaded rod		A_{se}	in. ² (mm ²)	0.078 (92)	0.142 (92)	0.226 (146)	0.335 (216)	0.462 (298)	0.606 (391)	0.969 (625)
Effective cross sectional area of reinforcing bar		A_{se}	in. ² (mm ²)	0.110 (71)	0.200 (129)	0.310 (200)	0.440 (284)	-	0.790 (510)	-

ADHESIVES

1. For installations between the minimum edge distance and 5 anchor diameters, the tabulated maximum torque must be reduced (multiplied) by a factor of 0.45.

Detail of Steel Hardware Elements used with Injection Adhesive System

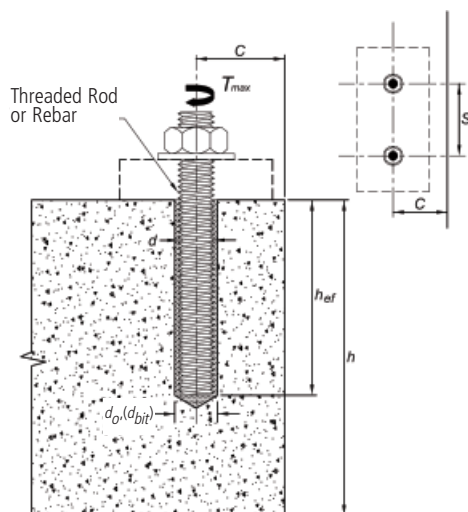

Threaded Rod and Deformed Reinforcing Bar Material Properties				
Steel Description (General)	Steel Specification (ASTM)	Nomial Anchor Size (inch)	Minimum Yield Strength, f_y (ksi)	Minimum Ultimate Strength, f_u (ksi)
Carbon rod	A 36 or F 1554 and Grade 36	3/8 through 1-1/4	36.0	58.0
Stainless rod (Alloy 304 / 316)	F 593, Condition CW	3/8 through 5/8	65.0	100.0
		3/4 through 1-1/4	45.0	85.0
High strength carbon rod	A 193, Grade B7	3/8 through 1-1/4	105.0	125.0
Grade 60 reinforcing bar	A 615, A 767, or A 996	3/8 through 1-1/4 (#3 through #8)	60.0	90.0
Grade 40 reinforcing bar	A 615	3/8 through 3/4 (#3 through #6)	40.0	70.0

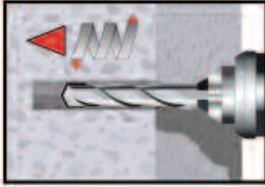
INSTALLATION INSTRUCTIONS (SOLID BASE MATERIALS)
DRILLING

1 - Drill a hole into the base material with a rotary hammer drill tool to the size and embedment required by the selected anchor (*reference installation specifications for threaded rod and reinforcing bar*). The tolerances of the carbide drill bit should meet the requirements of ANSI Standard B212.15.

Precaution: Wear suitable eye and skin protection. Avoid inhalation of dusts during drilling and/or removal.

Note! After drilling and prior to hole cleaning, all standing water in the drilled bore hole must be removed if present (e.g. vacuum, compressed air, etc.)

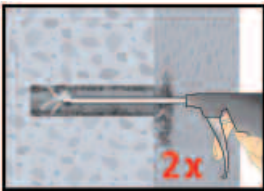
HOLE CLEANING → BLOW 2x, BRUSH 2x, BLOW 2x

2a - Starting from the bottom or back of the anchor hole, blow the hole clean using a compressed air nozzle (min. 90 psi) a minimum of *two* times (2x).

- Use a compressed air nozzle (min. 90 psi) for anchor rod 3/8" to 1-1/4" diameter or reinforcing bar (rebar) sizes #3 to #8.

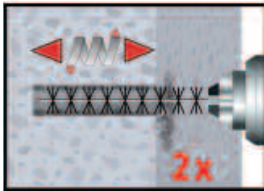

2b - Determine wire brush diameter (*reference hole cleaning equipment selection table*) and attach the brush with adaptor to a rotary drill tool or battery screw gun. Brush the hole with the selected wire brush a minimum of *two* times (2x). A brush extension (supplied by Powers Fasteners, Cat. #08282) should be used for holes drilled deeper than the listed brush length.

The wire brush diameter should be checked periodically during use. The brush must be replaced if it becomes worn (less than D_{min} , *reference hole cleaning equipment selection table*) or does not come into contact with the sides of the drilled hole.

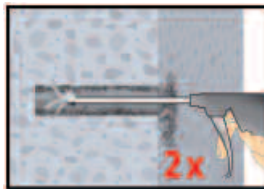

2c - Finally, blow the hole clean again a minimum of *two* times (2x).

- Use a compressed air nozzle (min. 90 psi) for anchor rod 3/8" to 1-1/4" diameter or reinforcing bar (rebar) sizes #3 to #8.

When finished the hole should be clean and free of dust, debris, ice, grease, oil or other foreign material.

(Continued on next page)

INSTALLATION INSTRUCTIONS (SOLID BASE MATERIALS)

PREPARING

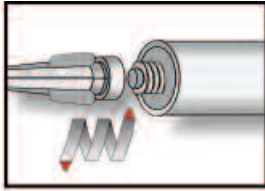

3- Check adhesive expiration date on cartridge label. Do not use expired product. Review Material Safety Data Sheet (MSDS) before use. Cartridge temperature must be between 50°F - 104°F (10°C - 40°C) when in use. Consideration should be given to the reduced gel time of the adhesive in warm temperatures.

Attach a supplied mixing nozzle to the cartridge. Do not modify the mixer in any way and make sure the mixing element is inside the nozzle. Load the cartridge into the correct dispensing tool. A new mixing nozzle must be used for every working interruption longer than the published working

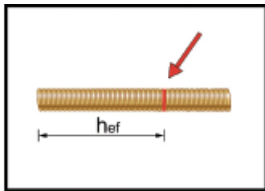

4- Prior to inserting the anchor rod or rebar into the filled bore hole, the position of the embedment depth has to be marked on the anchor. Verify anchor element is straight and free of surface damage.

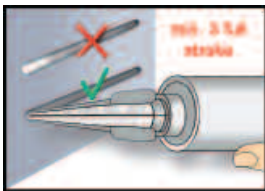

5- For new cartridges and nozzles: prior to dispensing into the anchor hole, squeeze out separately a minimum three full strokes of the mixed adhesive. Discard non-uniform adhesive until the mixed adhesive shows a consistent **gray** color.

Review and note the published working and cure times (*reference gel time and curing time table*) prior to injection of the mixed adhesive into the cleaned anchor hole.

INSTALLATION

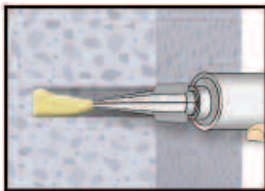

6- Fill the cleaned hole approximately two-thirds full with mixed adhesive starting from the bottom or back of the anchor hole. Slowly withdraw the mixing nozzle as the hole fills to avoid creating air pockets or voids. For embedment depth greater than 7-1/2" an extension nozzle (3/8" dia.) must be used with the mixing nozzle.

Piston plugs (see Adhesive Piston Plug Table) must be used with and attached to mixing nozzle and extension tube for horizontal and overhead installations with anchor rod from 3/4" to 1-1/4" diameter and rebar sizes #6 to #8. Insert piston plug to the back of the drilled hole and inject as described in the method above. During installation the piston plug will be naturally extruded from the drilled hole by the adhesive pressure.

With Piston Plug

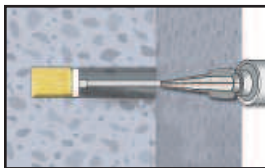

Attention! Do not install anchors overhead without proper training and installation hardware provided by Powers Fasteners. Contact Powers for details prior to use.

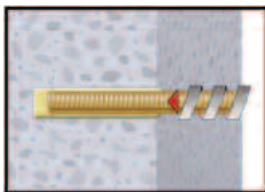

7- The anchor should be free of dirt, grease, oil or other foreign material. Push clean threaded rod or reinforcing bar into the anchor hole while turning slightly to ensure positive distribution of the adhesive until the embedment depth is reached. Observe the gel (working) time.

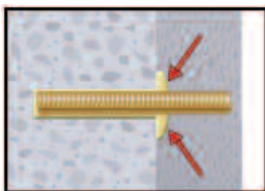

8- Be sure that the anchor is fully seated at the bottom of the hole and that some adhesive has flowed from the hole and all around the top of the anchor. If there is not enough adhesive in the hole, the installation must be repeated. For overhead applications the anchor must be secured from moving/falling during the cure time (e.g. wedges). Minor adjustments to the anchor may be performed during the gel time but the anchor shall not be moved after final placement and during cure.

(Continued on next page)

INSTALLATION INSTRUCTIONS (SOLID BASE MATERIALS)
CURING AND FIXTURE

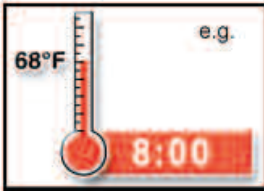

9- Allow the adhesive anchor to cure to the specified full curing time prior to applying any load (reference gel time and curing time table).

Do not disturb, torque or load the anchor until it is fully cured.

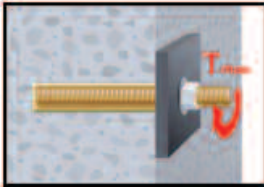

10- After full curing of the adhesive anchor, a fixture can be installed to the anchor and tightened up to the maximum torque (reference gel time and curing time table) by using a calibrated torque wrench.

Take care not to exceed the maximum torque for the selected anchor.

REFERENCE TABLES FOR INSTALLATION

Gel (working) Time and Curing Table			
Temperature of base material		Gel (working) time	Full curing time
°F	°C		
50	10	90 minutes	24 hours
68	20	25 minutes	8 hours
77	25	20 minutes	8 hours
86	30	15 minutes	6 hours
104	40	12 minutes	4 hours

Hole Cleaning Equipment Selection Table for Pure 50+							
Threaded rod diameter (inch)	Rebar size (no.)	ANSI drill bit diameter (inch)	Min. brush diameter, D _{min} (inches)	Brush length, L (inches)	Steel wire brush (Cat. #)	Blowout tool	Number of cleaning actions
3/8	#3	7/16	0.475	6-3/4	08284	Compressed air nozzle only (min. 90 psi)	2x blowing 2x brushing 2x blowing
1/2	#4	9/16	0.600	6-3/4	08285		
5/8	#5	11/16	0.735	7-7/8	08286		
		3/4	0.790	7-7/8	08278		
3/4	#6	7/8	0.920	7-7/8	08288		
7/8	-	1	1.045	11-7/8	08287		
1	#8	1-1/8	1.175	11-7/8	08289		
1-1/4	-	1-3/8	1.425	11-7/8	08290		

An SDS-plus adaptor (Cat. #08283) or Jacobs chuck style adaptor (Cat. #08296) is required to attach a steel wire brush to the drill tool.

Adhesive Piston Plugs					
Threaded rod diameter (inch)	Rebar size (no.)	ANSI drill bit diameter (inch)	Plug Size (inch)	Plastic Plug (Cat. #)	Horizontal and overhead installations
3/4	#6	7/8	7/8	08300	
7/8	#7	1	1	08301	
1	#8	1-1/8	1-1/8	08303	
1-1/4	-	1-3/8	1-3/8	08305	

A plastic extension tube (Cat# 08281) must be used with piston plugs.



Ultimate and Allowable Load Capacities for Pure50+ Installed with Threaded Rod into Normal Weight Concrete (based on bond strength/concrete capacity)^{1,2,3,4,5,6,7}

Rod Diameter d in.	Drill Diameter d _{bit} in.	Minimum Embedment Depth h _{ef} in.	Minimum Concrete Compressive Strength			
			3,000 psi		4,000 psi	
			Ultimate Tension Load Capacity (lbs.)	Allowable Tension Load Capacity (lbs.)	Ultimate Tension Load Capacity (lbs.)	Allowable Tension Load Capacity (lbs.)
3/8	7/16	3-3/8	9,725	2,430	9,725	2,430
1/2	9/16	4-1/2	15,240	3,810	17,745	4,435
5/8	11/16 or 3/4	5-5/8	22,870	5,720	28,200	7,050
3/4	7/8	6-3/4	31,765	7,940	36,470	9,120
7/8	1	7-7/8	39,615	9,905	45,745	11,435
1	1-1/8	9	38,695	9,925	66,950	16,740
		10	56,665	15,005	69,305	17,325
1-1/4	1-3/8	11-1/4	76,985	19,245	88,895	22,225

1. Allowable load capacities listed are calculated using an applied safety factor of 4.0. Consideration of safety factors of 10 or higher may be necessary depending on the application, such as life safety or overhead.
2. Linear interpolation may be used to determine allowable loads for intermediate embedments and compressive strengths.
3. The tabulated load values are applicable to single anchors installed at critical edge and spacing distances and where the minimum member thickness is 2.5 times the embedment depth.
4. The tabulated load values are for applicable for dry concrete. Holes must be drilled with a hammer drill and an ANSI carbide drill bit. Installations in wet concrete or in water-filled holes may require a reduction in capacity. Contact Powers Fasteners for more information concerning these installation conditions.
5. Adhesives experience reductions in capacity at elevated temperatures. See the in-service temperature chart for allowable load capacities.
6. Allowable bond strength/concrete capacity must be checked against allowable steel strength in tension to determine the controlling allowable load.
7. Allowable shear capacity is controlled by allowable steel strength for the given conditions.

Ultimate and Allowable Load Capacities for Pure50+ Installed with Reinforcing Bar into Normal Weight Concrete (based on bond strength/concrete capacity)^{1,2,3,4,5,6,7}

Bar Diameter d in.	Drill Diameter d _{bit} in.	Minimum Embedment Depth h _{ef} in.	Minimum Concrete Compressive Strength			
			3,000 psi		4,000 psi	
			Ultimate Tension Load Capacity (lbs.)	Allowable Tension Load Capacity (lbs.)	Ultimate Tension Load Capacity (lbs.)	Allowable Tension Load Capacity (lbs.)
#3	7/16	3-3/8	9,950	2,490	9,950	2,490
#4	9/16	4-1/2	16,340	4,085	18,045	4,510
#5	11/16 or 3/4	4	16,405	4,100	16,670	4,170
		5-5/8	22,955	5,740	25,345	6,335
#6	7/8	6-3/4	29,690	7,425	35,930	8,985
#8	1-1/8	9	48,465	12,115	65,270	16,320

1. Allowable load capacities listed are calculated using an applied safety factor of 4.0. Consideration of safety factors of 10 or higher may be necessary depending on the application, such as life safety or overhead.
2. Linear interpolation may be used to determine allowable loads for intermediate embedments and compressive strengths.
3. The tabulated load values are applicable to single anchors installed at critical edge and spacing distances and where the minimum member thickness is 2.5 times the embedment depth.
4. The tabulated load values are for applicable for dry concrete. Holes must be drilled with a hammer drill and an ANSI carbide drill bit. Installations in wet concrete or in water-filled holes may require a reduction in capacity. Contact Powers Fasteners for more information concerning these installation conditions.
5. Adhesives experience reductions in capacity at elevated temperatures. See the in-service temperature chart for allowable load capacities.
6. Allowable bond strength/concrete capacity must be checked against allowable steel strength in tension to determine the controlling allowable load.
7. Allowable shear capacity is controlled by allowable steel strength for the given conditions.

ADHESIVES



Allowable Load Capacities for Pure50+ Installed into Uncracked Normal-Weight Concrete with Threaded Rod and Reinforcing Bar (Based on Steel Strength)^{1,2,3,4,5}

ADHESIVES

Nominal Rod Diameter or Rebar Size (in. or #)	Steel Elements - Threaded Rod and Reinforcing Bar									
	A36 or F1554 Grade 36		A193, Grade B7		F 593, CW (SS)		Grade 60 Rebar		Grade 40 Rebar	
	Tension (lbs.)	Shear (lbs.)	Tension (lbs.)	Shear (lbs.)	Tension (lbs.)	Shear (lbs.)	Tension (lbs.)	Shear (lbs.)	Tension (lbs.)	Shear (lbs.)
3/8 or #3	2,115	1,090	4,375	2,225	3,630	1,870	2,655	1,320	2,210	1,310
1/2 or #4	3,755	1,940	7,775	4,055	6,470	3,330	4,710	2,345	3,925	2,380
5/8 or #5	5,870	3,025	12,150	6,260	10,130	5,210	7,370	3,670	6,135	3,690
3/4 or #6	8,455	4,355	17,495	9,010	12,400	6,390	10,590	5,285	8,835	5,235
7/8 or #7	11,510	5,930	23,810	12,265	16,860	8,680	14,425	7,195	12,025	7,140
1 or #8	15,035	7,745	31,100	16,020	22,020	11,340	18,840	9,400	15,708	9,400
1-1/4	23,485	12,100	48,560	25,035	34,420	17,780				

1. Allowable load capacities listed are calculated for the steel element type. Consideration of applying additional safety factors may be necessary depending on the application, such as life safety or overhead.
2. The tabulated load values are applicable to single anchors at critical edge and spacing distances and where the minimum member thickness is 2.5 times the embedment depth.
3. The tabulated load values are for dry concrete. Holes must be drilled with a hammer drill and an ANSI carbide drill bit. Installation in wet concrete or installations in water-filled holes may require a reduction in capacity. Contact Powers Fasteners for more information concerning these installation conditions.
4. Allowable shear capacity is controlled by steel strength for the given conditions.
5. Allowable steel strength in tension must be checked against allowable bond strength/concrete capacity in tension to determine the controlling allowable load.

In-Service Temperature Chart For Allowable Load Capacities¹

BASE MATERIAL TEMPERATURE		REDUCTION FACTOR FOR TEMPERATURE
°F	°C	
32	0	0.89
50	5	1.00
70	10	1.00
110	20	1.00
130	30	0.82
150	40	0.73
180	50	0.48

1. Linear interpolation may be used to derive reduction factors between those listed.

ORDERING INFORMATION

Pure50+ Cartridges

Cat No.	Description	Std. Carton	Pallet
08605	Pure50+ 21 fl. oz. dual cartridge	12	540
08651	Pure50+ 51 fl. oz. cartridge	8	216



One Pure50+ mixing nozzle is packaged with each cartridge. Pure50+ mixing nozzles must be used to ensure complete and proper mixing of the adhesive.

Cartridge System Mixing Nozzles

Cat No.	Description	Std. Pack/Box	Std. Carton
08294	Extra mixing nozzle (with a 8" extension) for Pure50+	2	24
08281	Mixing nozzle extension, 8" minimum	2	24



ORDERING INFORMATION (Continued)

Dispensing Tools for Injection Adhesive

Cat No.	Description	Std. Box	Std. Carton
08409	21 fl. oz. Standard metal manual tool	1	10
08421	21 fl. oz. High performance manual tool	1	10
08442	21 fl. oz. Battery powered tool (cordless)	1	-
08459	21 fl. oz. Pneumatic tool	1	-
08438	51 fl. oz. Pneumatic tool	1	-



Pure50+ Epoxy Adhesive Anchor System



Hole Cleaning Tools and Accessories

Cat No.	Description	Std. Package
08284	Wire brush for 7/16" ANSI hole (3/8" rod or #3 rebar)	1
08285	Wire brush for 9/16" ANSI hole (1/2" rod or #4 rebar)	1
08286	Wire brush for 11/16" ANSI hole (5/8" rod or #5 rebar)	1
08327	Wire brush for 3/4" ANSI hole (1/2" rod or #4 rebar)	1
08287	Wire brush for 7/8" ANSI hole (3/4" rod or #6 rebar)	1
08288	Wire brush for 1" ANSI hole (7/8" rod)	1
08289	Wire brush for 1-1/8" ANSI hole (1" rod or #8 rebar)	1
08290	Wire brush for 1-3/8" ANSI hole (1-1/4" rod)	1
08283	SDS-plus adapter for steel brushes	1
08296	Standard drill adapter for steel brushes (e.g. Jacobs Chuck)	1
08282	Steel brush extension, 12"	1
08292	Air compressor nozzle with extension	1
08465	Adjustable torque wrench with 1/2" square drive (10 to 150 ft.-lbs.)	1
08466	Adjustable torque wrench with 1/2" square drive (25 to 250 ft.-lbs.)	1



Adhesive Pistons

Cat. No.	Description	ANSI Drill Dia.	Threaded Rod Size	Reinforcing Bar Size	Std. Bag	Std. Ctd.
08300	7/8" Plug	7/8"	3/4"	#6	10	100
08301	1" Plug	1"	7/8"	#7	10	100
08303	1-1/8" Plug	1-1/8"	1"	#8	10	100
08305	1-3/8" Plug	1-3/8"	1-1/4"	-	10	100



ADHESIVES